

No compression load on ceiling  
Possible lateral load of 8kg  
2 fixed pins in shear with ceiling

No Load Bearing on 1st Floor  
Fixings used to maintain rail guage.









2 x Bugle Screw Guide Fixing

Optional Non-penetrating  
Fixings To Ground Floor

Compression Load  
330kg / 3250 N

**Technical Information:**

The Trio / Trio Thru Car

-  **DRIVE SYSTEM:**  
Roped Drum, Braked Gear Motor Drive
-  **CAPACITY:**  
MAX Capacity 220kg / 2-3 Persons
-  **TRAVEL:**  
Up to 4000mm
-  **NO of FLOORS:**  
2 Maximum
-  **SUPPLY VOLTAGE:**  
240v 1PH 50HZ
-  **RUNNING CURRENT:**  
3.2 AMP
-  **STARTING CURRENT:**  
4.0 AMP
-  **STANDARD COLOUR:**  
Off White / Cream (RAL 9003)  
(Other colours available)

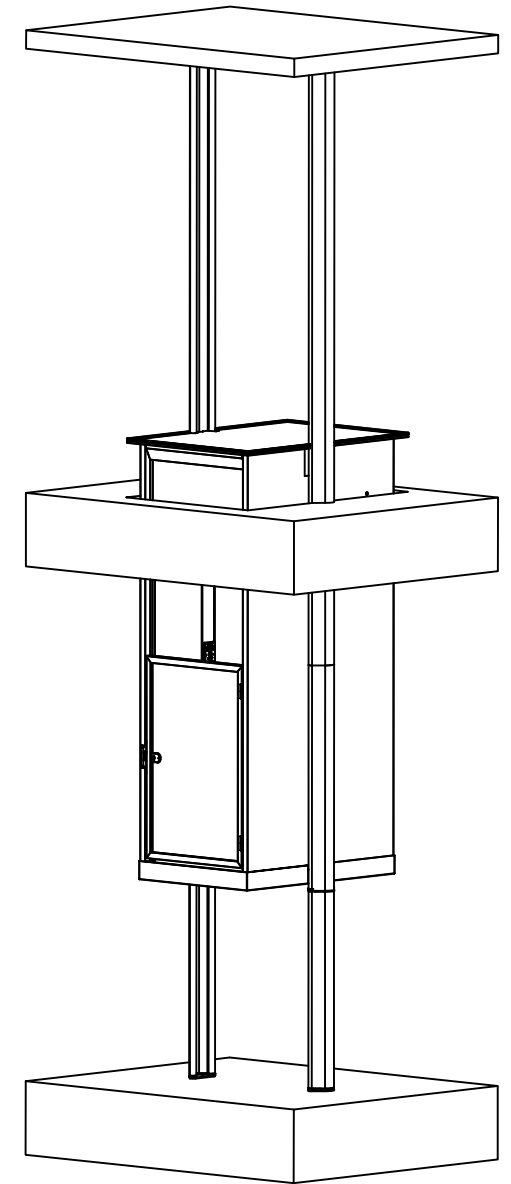

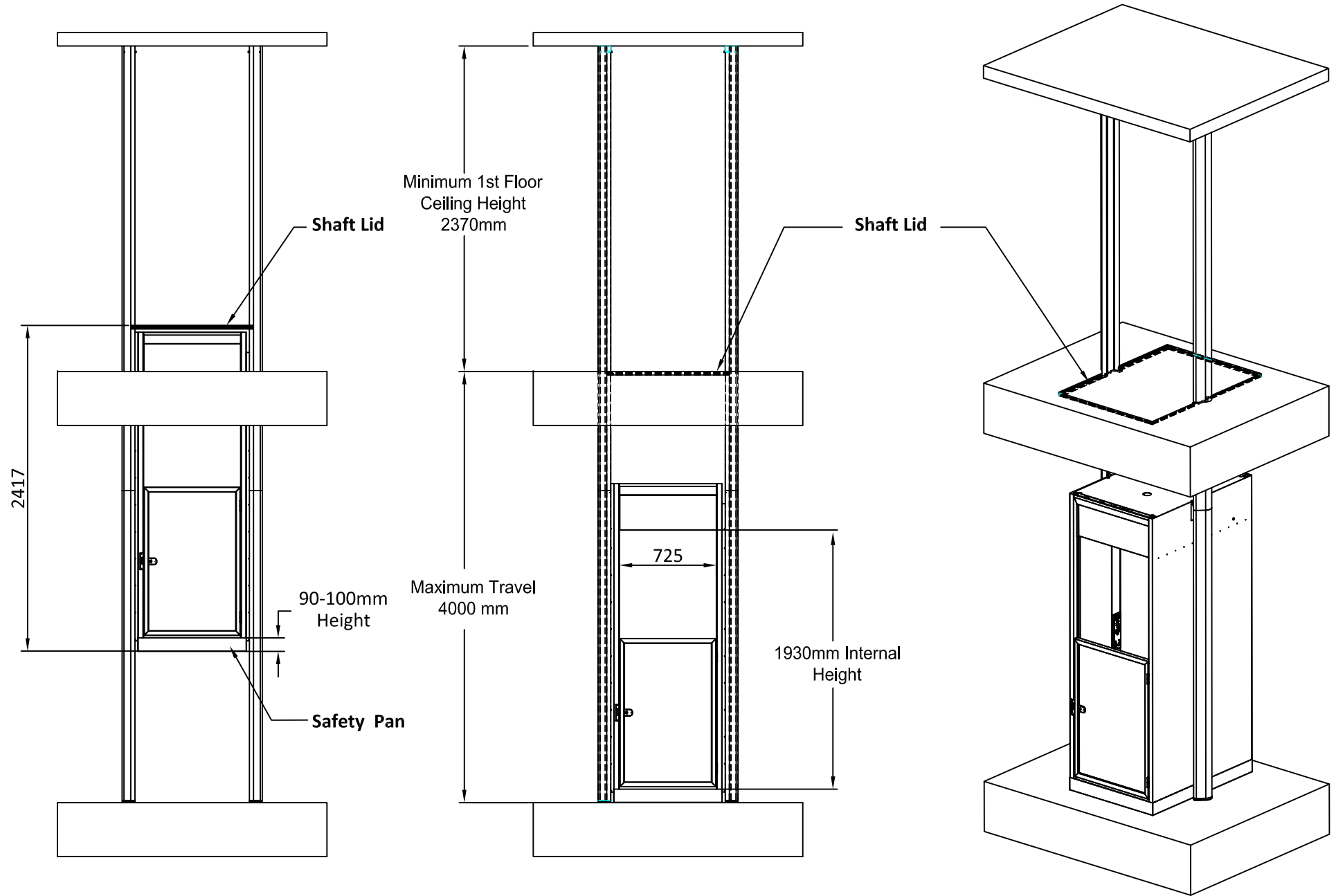

PRINT MAY BE REDUCED - DO NOT SCALE.

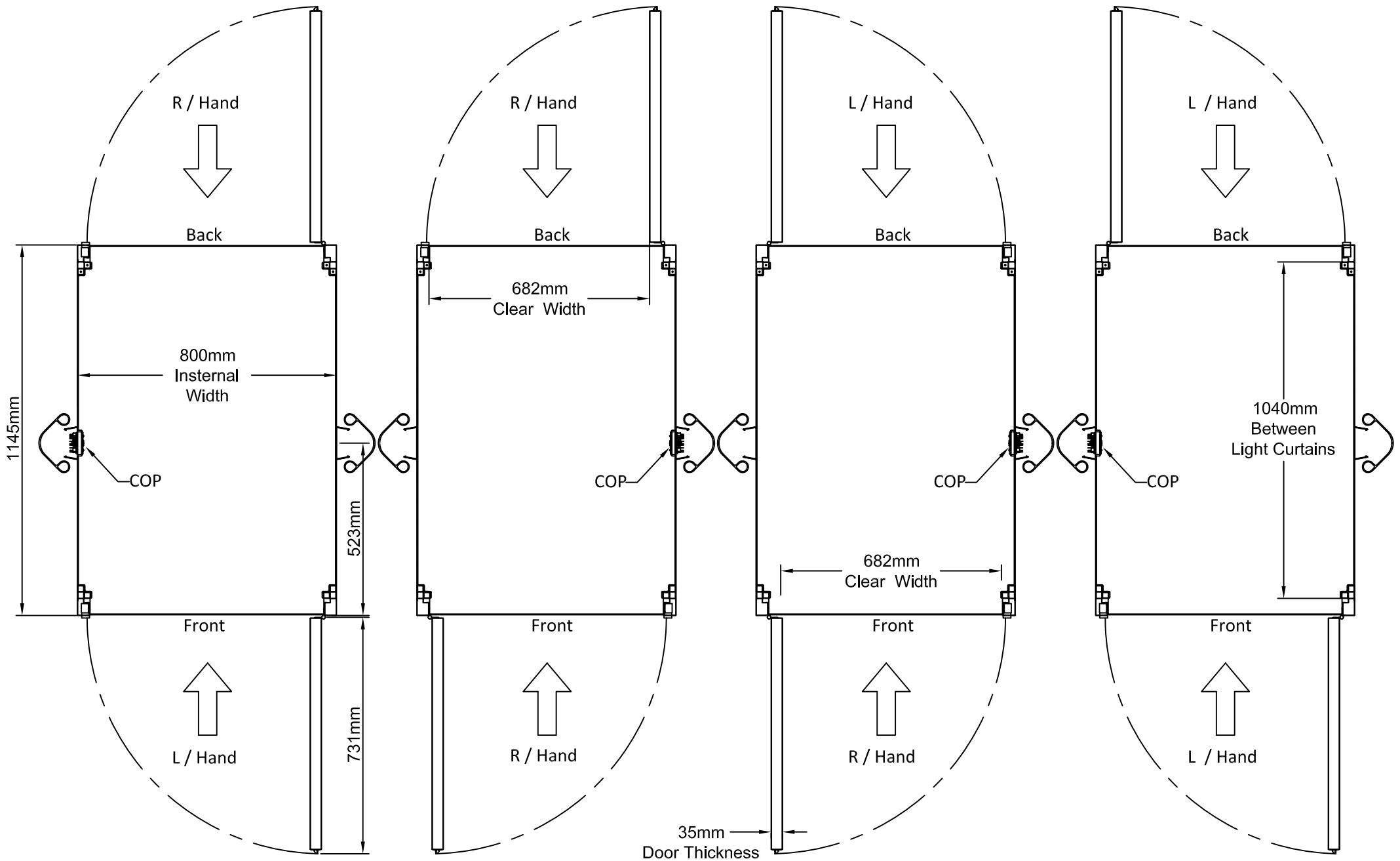

© Stiltz Ltd. 2013	TITLE
Drawn W Wang Date 2015/5/29	Trio Thru Car Configuration
DIMENSIONS IN MM UNLESS OTHERWISE NOTED	A4 Dwg No
THIRD ANGLE PROJECTION - AS 1100	SCALE:

